

Lead (Pb) Free Product RoHS compliant

PT008-05 mold type Phototransistor

PT008-05 is an epoxy mold type phototransistor featuring high photo current.

This phototransistor consists of a chip with 0.6*0.6mm active area mounted on a lead frame with a $\Phi 5$ clear epoxy lens.

This device exhibits a half angle of sensitivity $\pm 40^\circ$ and response time of 20us.

◆ Specifications

- | | |
|--------------------|----------------------------|
| 1) Product Name | Mold type Photo Transistor |
| 2) Type No. | PT008-05 |
| 3) Chip | |
| (1) Chip Size | 0.8mm*0.8mm |
| (2) Active Area | 0.6mm*0.6mm |
| 4) Package | |
| (1) Type | $\Phi 5$ Epoxy Mold |
| (2) Resin Material | Clear Epoxy Resin |
| (3) Lead Frame | Soldered (Pb-free) |

◆ Outer dimension (Unit : mm)

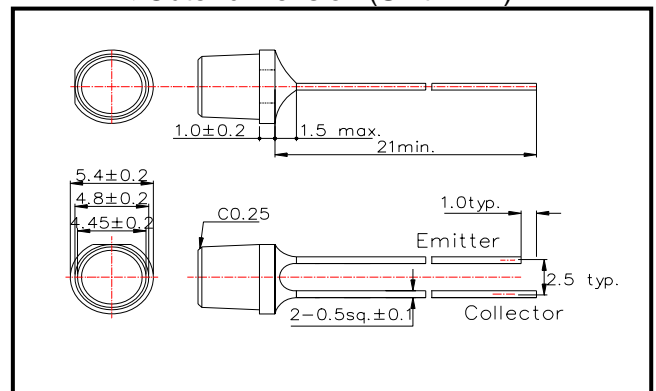

◆ Absolute Maximum Ratings [Ta=25°C]

Item	Symbol	Maximum Rated Value	Unit
Collector-Emitter Breakdown Voltage	V _{CEO}	30	V
Emitter-Collector Breakdown Voltage	V _{ECO}	5	V
Collector Current	I _c	10	mA
Collector Dissipation	P _c	50	mW
Operating Temperature	T _{OPR}	-25 ~ +100	°C
Storage Temperature	T _{STG}	-30 ~ +125	°C
Soldering Temperature	T _{SOL}	240	°C

‡Soldering condition: Soldering condition must be completed within 2 seconds at 240°C

◆ Electro-Optical Characteristics [Ta=25°C]

Item	Symbol	Condition	Minimum	Typical	Maximum	unit
Photo Current	I _L	V _{CE} =5V, L=1000Lx	2	4		mA
Collector Dark Current	I _D	V _{CE} =5V			100	nA
Collector Emitter Satu. Voltage	V _{CE(S)}	I _c =2mA, L=1000Lx			0.2	V
Spectral Responsivity (Peak)	P			900		nm
Half Angle of Sensitivity				± 40		deg.
Rise/Fall Time(10%~90%)	t _r	R _L =1K Ω , V _{CE} =5V		20		us
	t _f	I _c =1mA		20		us