

L910-66-60 epoxy lens type Infrared illuminator

L910-66-60 is a wide viewing and extremely high output power illuminator assembled with a total of 60 high efficiency AlGaAs diode chips, mounted on a metal stem TO-66 with AlN ceramics and covered with double coated clear silicone and epoxy resin.

These devices are designed for high current operation with proper heat sinking to improve thermal conductive efficiency.

◆ Features

- 1) high reliability
- 2) compact(TO-66)package
- 3) high output power at 910nm

◆ Applications

- 1) For IR search light
- 2) For CCD lighting

◆ Specifications

- | | |
|---------------------|-------------------------------|
| 1) Product name | IR illuminator |
| 2) Spec. No. | L910-66-60 |
| 3) Chip | |
| (1) Material | AlGaAs |
| (2) Peak wavelength | 910nm |
| 4) Package | |
| (1) Stem | TO-66 stem with AlN |
| (2) Lens | Clear silicone and epoxy lens |

◆ Outer dimension (Unit:mm)

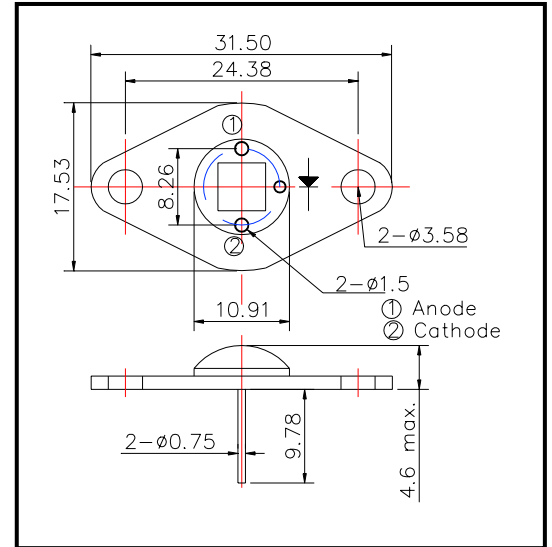

◆ Absolute Maximum Ratings

Item	Symbol	Maximum Rated Value	Unit	Ambient Temperature
Power Dissipation	P _D	7.5	W	T _a =25°C
Forward Current	I _F	1.0	A	T _a =25°C
Pulse Forward Current	I _{FP}	2.5	A	T _a =25°C
Reverse Voltage	V _R	50	V	T _a =25°C
Operating Temperature	T _{OPR}	-30 ~ +80	°C	
Storage Temperature	T _{STG}	-30 ~ +100	°C	
Soldering Temperature	T _{SOL}	240	°C	

‡Pulse Forward Current condition: Duty=1% and Pulse Width=1us.

‡Soldering condition : Soldering condition must be completed within 3 seconds at 260

◆ Electro-Optical Characteristics

Item	Symbol	Condition	Minimum	Typical	Maximum	Unit
Forward Voltage	V _F	I _F =800mA		7.0		V
Reverse Voltage	V _R	I _R =10uA	50			V
Total Radiated Power	P _O	I _F =800mA		600		mW
Total Radiated Power	P _O	I _{FP} =5A		3500		mW
Radiant Intensity	I _E	I _F =800mA		200		mW/sr
Peak Wavelength	λ _P	I _F =800mA	900	910	930	nm
Half Width	Δλ	I _F =800mA		40		nm
Viewing Half Angle	θ _{1/2}	I _F =800mA		±60		deg.

‡Heat sink is required thermal resistance <8K/W