

# EDC660D-1100

## High Power Top LED

EDC660D-1100 is an AlGaInP LED mounted on the 3.5\*3.5 mm ceramics package. These devices are available to be operated and 710mW at IFP=1A.

### ◆ Specifications

- 1) Product Name      High Power Top LED
- 2) Type No.            EDC660D-1100
- 3) Chip
  - (1) Chip Material      AlGaInP
  - (2) Chip Dimension    1000um\*1000um
  - (3) Chip Number       1pce
  - (4) Peak Wavelength  660nm typ.
- 4) Package
  - (1) Lead Frame Die    Ceramics
  - (3) Lens                 Silicone Resin



### ◆ Absolute Maximum Ratings [Ta=25°C]

Item	Symbol	Maximum Rated Value	Unit
Power Dissipation	PD	1500	mW
Forward Current	IF	500	mA
Pulse Forward Current	IFP	1000	mA
Reverse Voltage	VR	5	V
Thermal Resistance	Rthja	10	K/W
Junction Temperature	Tj	120	°C
Operating Temperature	TOPR	-40 ~ +100	°C
Storage Temperature	TSTG	-40 ~ +100	°C
Soldering Temperature	TSOL	250	°C

‡Pulse Forward Current condition: Duty=1% and Pulse Width=10us.

‡Soldering condition: Soldering condition must be completed within 5 seconds at 250°C

## ♦ Electro-Optical Characteristics [Ta=25°C typ.]

Item	Symbol	Condition	Minimum	Typical	Maximum	Unit
Forward Voltage	V <sub>F</sub>	I <sub>F</sub> =350mA		2.3	3.0	V
	V <sub>FP</sub>	I <sub>FP</sub> =1A		2.7		
Radiated Power	P <sub>O</sub>	I <sub>F</sub> =350mA	150	250		mW
		I <sub>FP</sub> =1A		710		
Radiant Intensity	I <sub>E</sub>	I <sub>F</sub> =350mA		80		mW/sr
		I <sub>FP</sub> =1A		220		
Luminous Flux	Φ <sub>V</sub>	I <sub>F</sub> =350mA		19		lm
		I <sub>FP</sub> =1A		53		
Peak Wavelength	λ <sub>P</sub>	I <sub>F</sub> =350mA	650	660	670	nm
Dominant Wavelength	λ <sub>D</sub>	I <sub>F</sub> =350mA		640		nm
Half Width	Δλ	I <sub>F</sub> =350mA		16		nm
Viewing Half Angle	θ <sub>1/2</sub>	I <sub>F</sub> =100mA		±65		deg.
Rise Time	t <sub>r</sub>	I <sub>F</sub> =350mA		90		ns
Fall Time	t <sub>f</sub>	I <sub>F</sub> =350mA		90		ns

‡Radiated Power is measured by S3584-08.

‡Radiant Intensity is measured by CIE127-2007 Condition B.

## ♦ Outer dimension (Unit: mm)

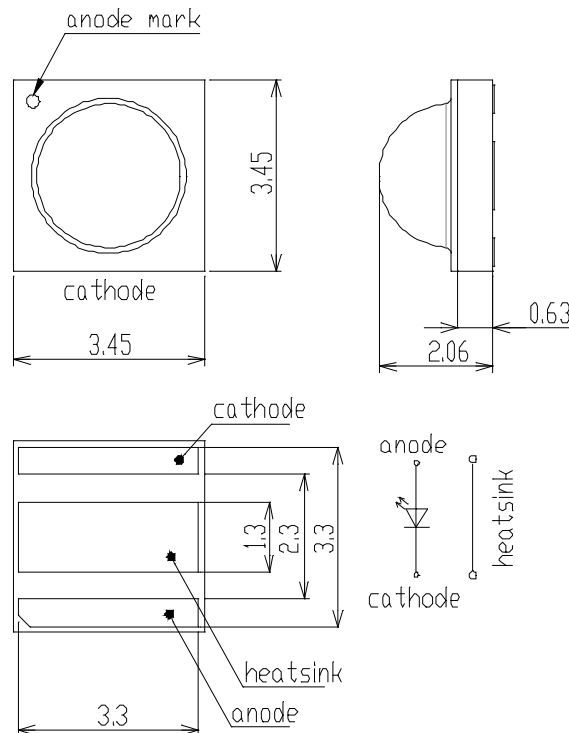

Forward Current - Forward Voltage

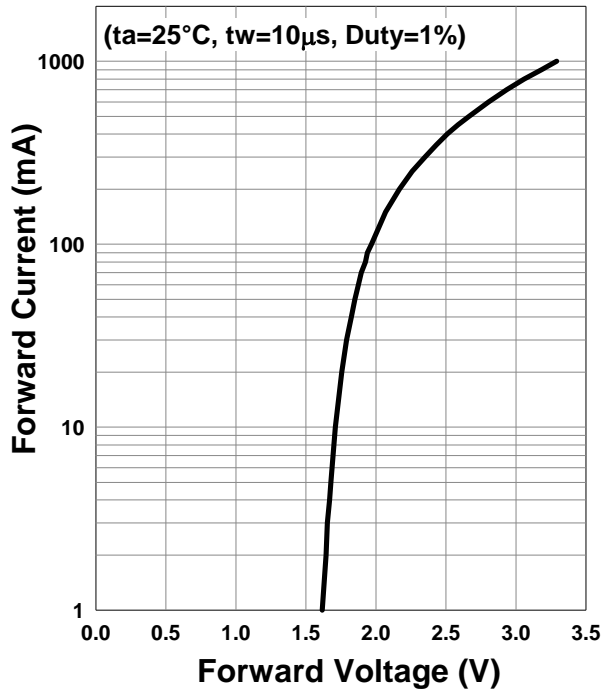

Relative Radiant Intensity - Forward Current

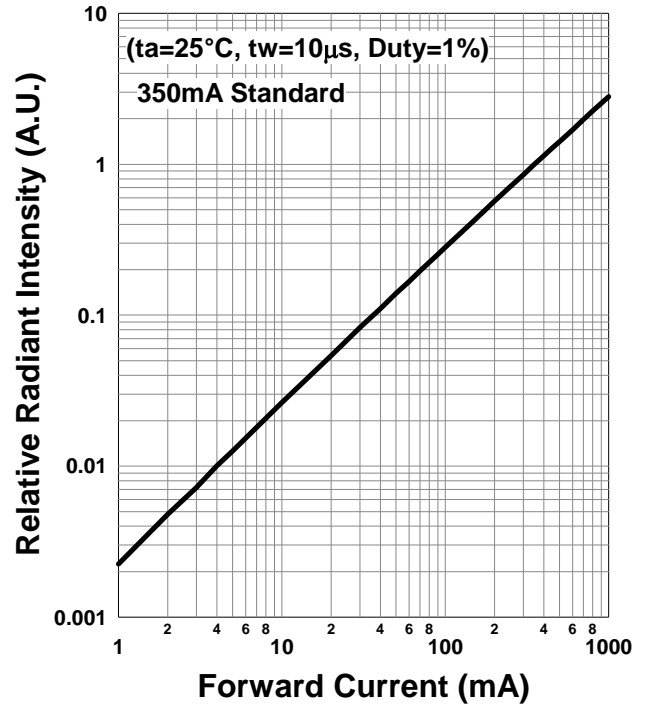

Forward Current - Pulse Duration

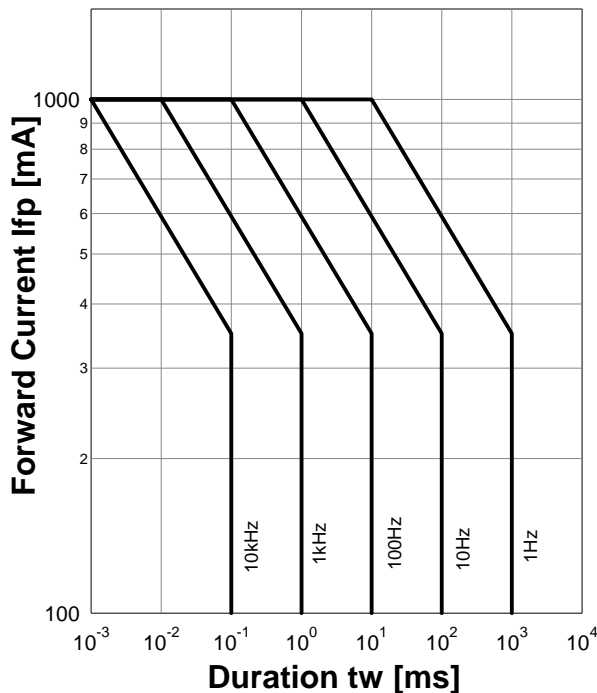

Allowable Forward Current - Ambient Temperature

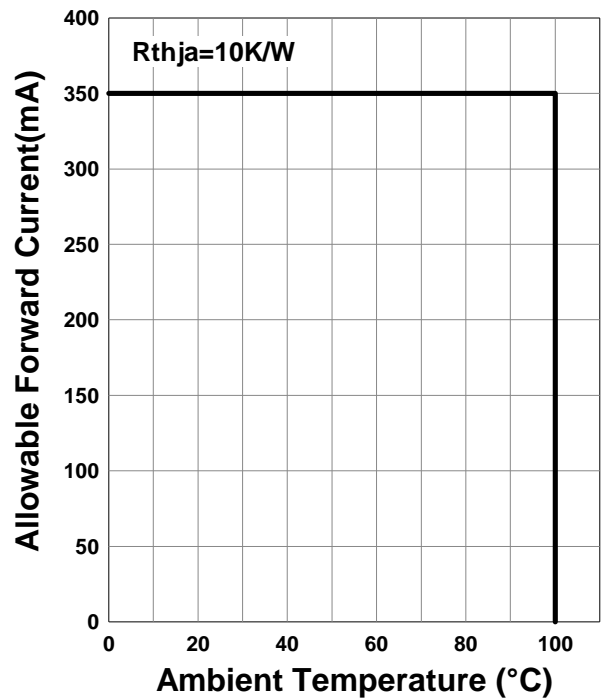

**Forward Voltage - Ambient Temperature**

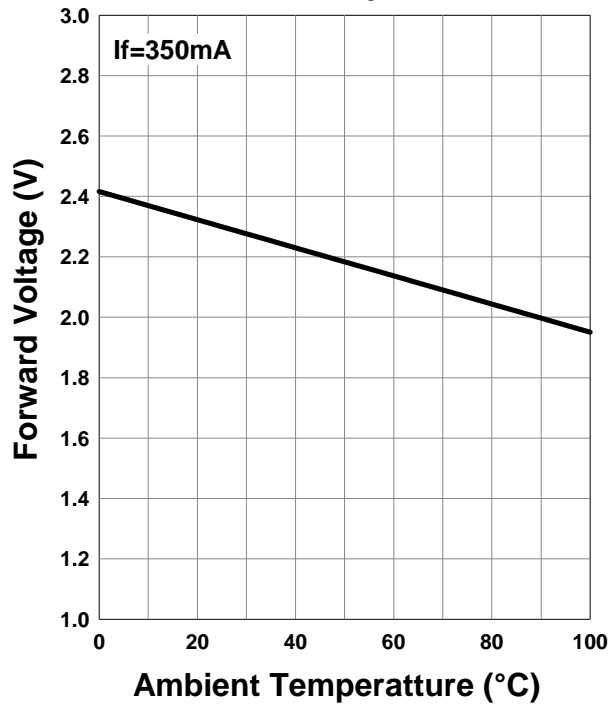

**Relative Radiant Intensity - Ambient Temperature**

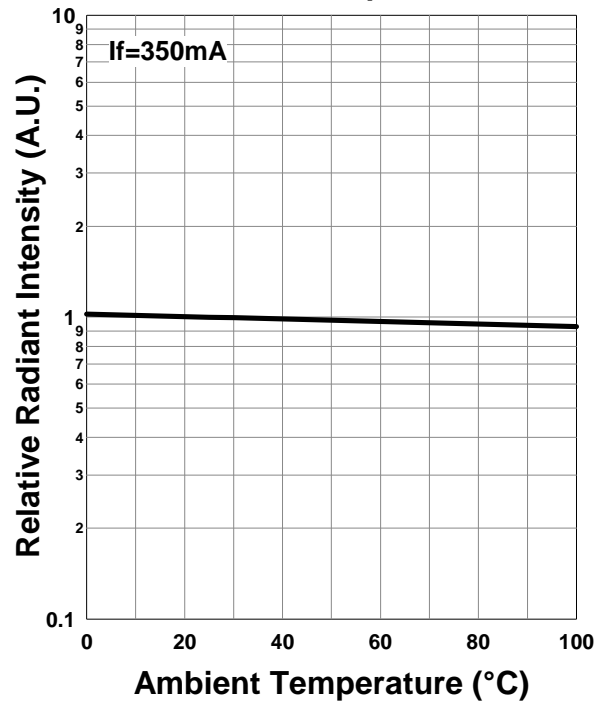

**Peak Wavelength - Ambient Temperature**

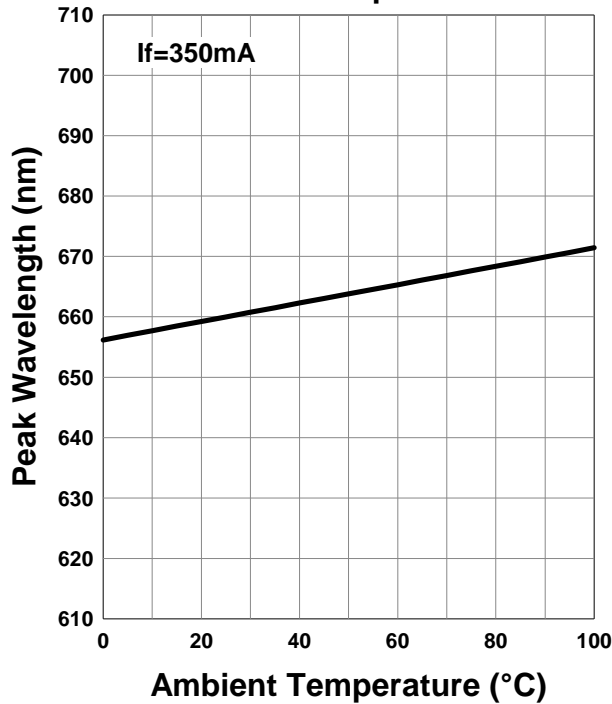

Relative Spectral Emission

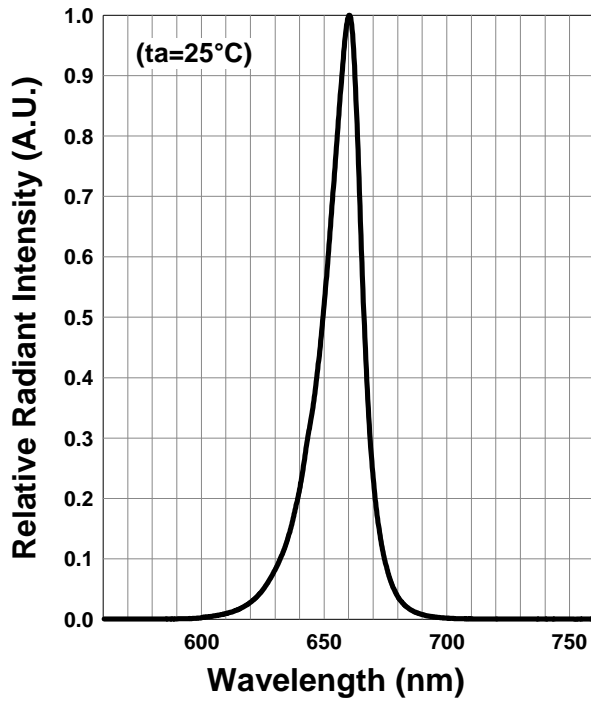

Radiation Characteristics

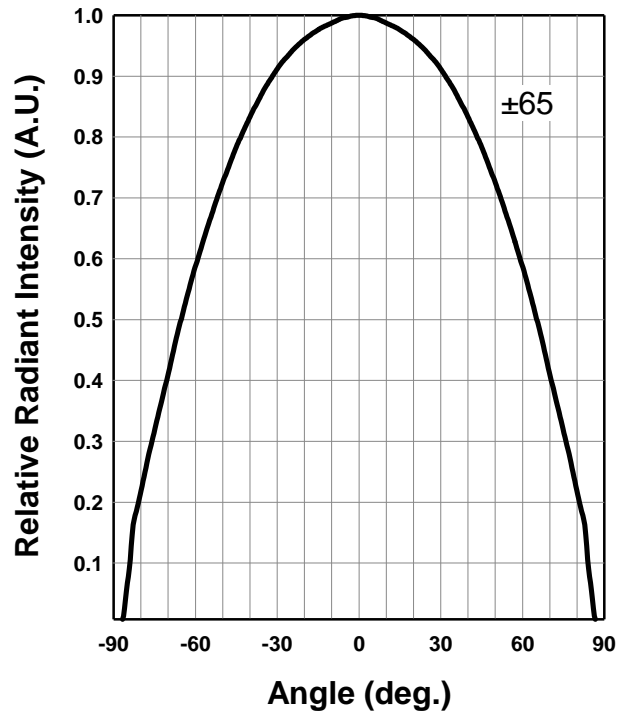

Radiation Characteristics

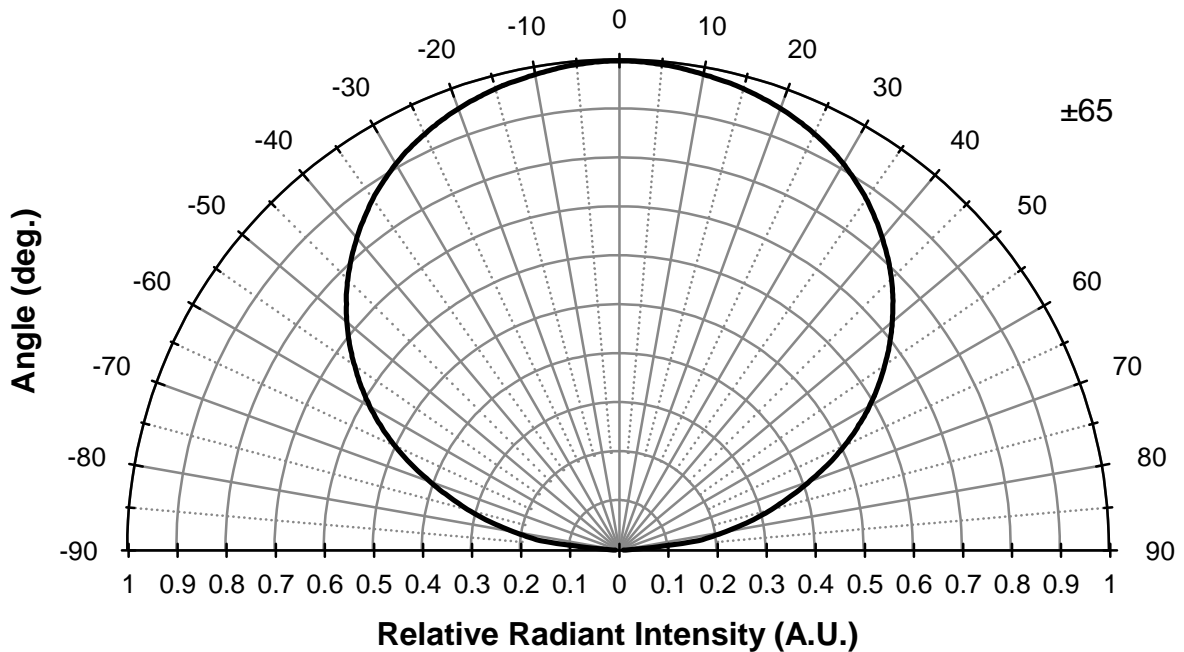

## ◆Wrapping

Moisture barrier bag aluminum laminated film with a desiccant to keep out the moisture absorption during the transportation and storage.

**SMD LED STORAGE AND HANDLING PRECAUTIONS****< Storage Conditions before Opening a Moisture-Barrier Aluminum Bag >**

- Before opening a moisture-barrier aluminum bag, please store it at <30°C, <60%RH. Please note that the maximum shelf life is 12 months under these conditions.

**< Storage Conditions after Opening a Moisture-Barrier Aluminum Bag >**

- After opening a moisture-barrier aluminum bag, store the aluminum bag and silica gel in a desiccator.
- After opening the bag, please solder the LEDs within 72 hours in a room with 5 - 30°C, <50%RH.
- Please put any unused, remaining LEDs and silica gel back in the same aluminum bag and then vacuum-seal the bag.
- It is recommended to keep the re-sealed bag in a desiccator at <30%RH.

**< Notes about Re-sealing a Moisture-Barrier Aluminum Bag >**

- When vacuum-sealing an opened aluminum bag, if you find the moisture-indicator of the silica gel has changed to pink from blue (indicating a relative humidity of 30 % or more), please do not use the unused LEDs, the aluminum bag, or the silica gel.

**< Notes about Opening a Re-sealed Moisture-Barrier Aluminum Bag >**

- When opening a vacuumed and re-sealed aluminum bag in order to use the remaining LEDs stored in the bag, if you find that the moisture-indicator of the silica has changed to pink, please do not use the LEDs.

※The 72-hour- long floor life does not include the time while LEDs are stored in the moisture-barrier aluminum bag.

However, we strongly recommend to solder the LEDs as soon as possible after opening the aluminum bag.

**Disclaimer**

Product specifications and data shown in this product catalog are subject to change without notice for the purposes of improving product performance, reliability, design, or otherwise.

Product data and parameters in this catalog are typical values based on reasonably up-to-date measurements. Product data and parameters may vary by user application and over time.

Products shown in this catalog are intended to be used for general electronic equipment. Products are not guaranteed for applications where product malfunction or failure may cause personal injury or death, including but not limited to life-supporting / saving devices, medical devices, safety devices, airplanes, aerospace equipment, automobiles, traffic control systems, and nuclear reactor control systems.

2015.01