

Φ3.3mm Plastic 850nm Laser Module

P_o: < 3mW

Features

1. APC (auto power control) IC inside
2. Low current consumption of the APC circuit
3. Much smaller LD module
4. Surge current protection
5. High quality lens for output beam



Absolute maximum ratings

Item	Symbol	Rating	Unit
Power supply voltage	V _{cc}	3.3	V
Laser Module optical output power	P _o	<3	mW
Operation temperature	T _{opr}	0~40	°C
Storage temperature	T _{stg}	0~60	°C

Electrical and optical characteristics (T_c=25 °C)

Item	Symbol	Min.	Typ.	Max	Unit	Condition
Wavelength	λ	-	845	-	nm	P _o = 3mW
Operation current	I _{op}	-	-	40	mA	P _o = 3mW V _{cc} =3V
Operation voltage	V _{op}	2.5	-	3.3	Volt	
Laser Beam spot size at 10m					<20mm	
Divergence angle					2 mrad	
Mean time to failure (MTTF) 25°C					>10000 hrs	

Outline dimensions (Units: mm)

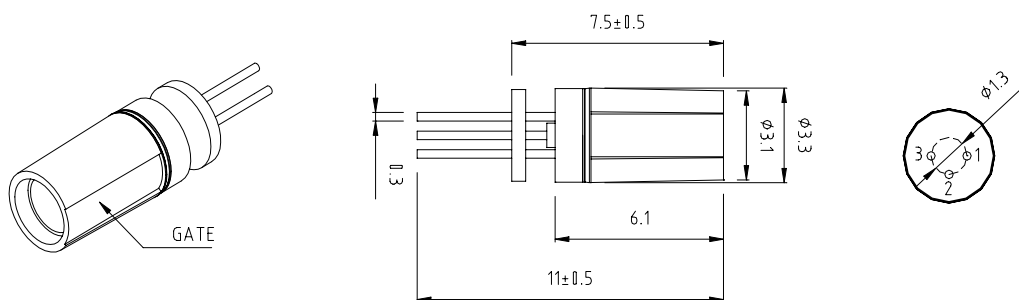

1. Do not look into the laser beam directly by eyes. The laser beam may cause severe damage to human eyes.
2. Optical Lens is made of plastic or glass. Do not contaminate lens by soiling, oil or chemical.

PIN Assignment:

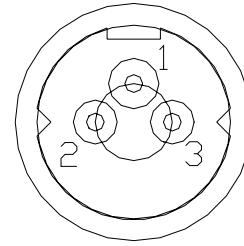
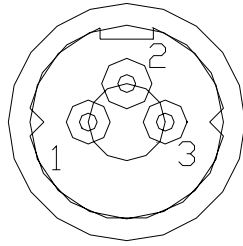

A type : Heat sink stand (-)

B type :Heat sink stand (+)

Pin 1 : Vcc

Pin 2 : GND

Pin 3 : NC (No external connection)

Instruction manual

1. DC Power connection mode 1

A type : Heat sink stand (-)

B type :Heat sink stand (+)

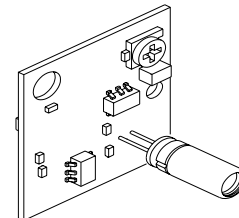
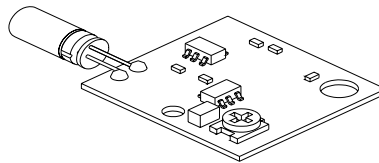
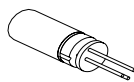
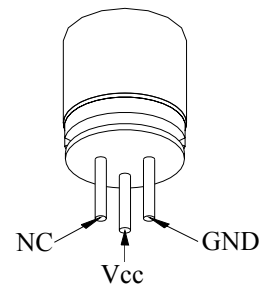
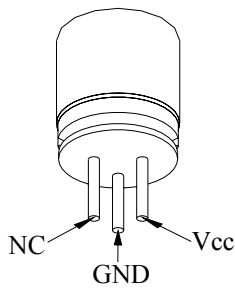

2. DC Power connection mode 2

